

G2R1000MT17D

1700 V 1000 mΩ SiC MOSFET



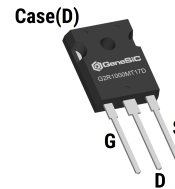
Silicon Carbide MOSFET
N-Channel Enhancement Mode

V_{DS}	=	1700 V
$R_{DS(ON)(Typ.)}$	=	1000 mΩ
$I_D(T_C = 100^\circ C)$	=	3 A

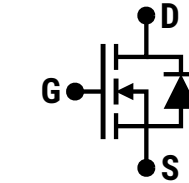
Features

- G2R™ Technology with +20 V Gate Drive
- Superior $Q_G \times R_{DS(ON)}$ Figure of Merit
- Superior Cost-Performance Index
- Low Capacitances and Low Gate Charge
- Very Low Switching Losses

Package



TO-247-3



D = Drain
G = Gate
S = Source



Advantages

- Compatible with Fly-back Controllers
- Reduction of System Complexity
- High Frequency Switching
- Improved Thermal Capability

Applications

- Auxiliary Power Supply
- Solar Inverters (String and Central)
- Infrastructure Chargers
- Industrial Motors (AC Servos)
- General Purpose Inverters
- Pulsed Power
- Piezo Drivers
- Ion Beam Generators

Absolute Maximum Ratings (At $T_C = 25^\circ C$ Unless Otherwise Stated)

Parameter	Symbol	Conditions	Values	Unit	Note
Drain-Source Voltage	$V_{DS(max)}$	$V_{GS} = 0 V, I_D = 100 \mu A$	1700	V	
Gate-Source Voltage (Dynamic)	$V_{GS(max)}$		-10 / +25	V	
Gate-Source Voltage (Static)	$V_{GS(op)}$	Recommended Operation	-5 / +20	V	
Continuous Forward Current	I_D	$T_C = 25^\circ C, V_{GS} = -5 / +20 V$	5	A	Fig. 15
		$T_C = 100^\circ C, V_{GS} = -5 / +20 V$	3		
		$T_C = 135^\circ C, V_{GS} = -5 / +20 V$	2		
Pulsed Drain Current	$I_{D(pulse)}$	$t_P \leq 3 \mu s, D \leq 1\%, V_{GS} = 20 V, \text{Note 1}$	8	A	Fig. 14
Power Dissipation	P_D	$T_C = 25^\circ C$	44	W	Fig. 16
Non-Repetitive Avalanche Energy	E_{AS}	$L = 90 mH, I_{AS} = 1.0 A$	45	mJ	
Operating and Storage Temperature	T_j, T_{stg}		-55 to 175	$^\circ C$	

Thermal/Package Characteristics

Parameter	Symbol	Conditions	Values			Unit	Note
			Min.	Typ.	Max.		
Thermal Resistance, Junction - Case	R_{thJC}		2.97	3.41		$^\circ C/W$	Fig. 13
Weight	W_T		6.1			g	
Mounting Torque	T_M	Screws to Heatsink		1.1		Nm	

Note 1: Pulse Width t_P Limited by $T_{j(max)}$

Electrical Characteristics (At $T_C = 25^\circ\text{C}$ Unless Otherwise Stated)

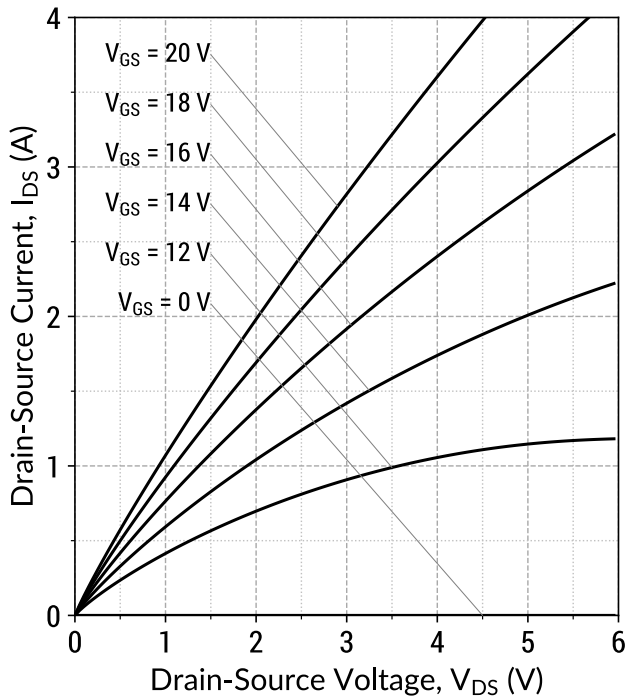
Parameter	Symbol	Conditions	Values			Unit	Note
			Min.	Typ.	Max.		
Drain-Source Breakdown Voltage	V_{DSS}	$V_{GS} = 0\text{ V}, I_D = 100\ \mu\text{A}$	1700			V	
Zero Gate Voltage Drain Current	I_{DSS}	$V_{DS} = 1700\text{ V}, V_{GS} = 0\text{ V}$		1		μA	
Gate Source Leakage Current	I_{GSS}	$V_{DS} = 0\text{ V}, V_{GS} = 25\text{ V}$			100	nA	
		$V_{DS} = 0\text{ V}, V_{GS} = -10\text{ V}$			-100		
Gate Threshold Voltage	$V_{GS(th)}$	$V_{DS} = V_{GS}, I_D = 1.0\text{ mA}$	2.5	4.50		V	Fig. 9
		$V_{DS} = V_{GS}, I_D = 1.0\text{ mA}, T_j = 175^\circ\text{C}$		3.50			
Transconductance	g_{fs}	$V_{DS} = 10\text{ V}, I_D = 2\text{ A}$		0.76		S	Fig. 4
		$V_{DS} = 10\text{ V}, I_D = 2\text{ A}, T_j = 175^\circ\text{C}$		0.83			
Drain-Source On-State Resistance	$R_{DS(on)}$	$V_{GS} = 20\text{ V}, I_D = 2\text{ A}$		1000	1250	$\text{m}\Omega$	Fig. 5-8
		$V_{GS} = 20\text{ V}, I_D = 2\text{ A}, T_j = 175^\circ\text{C}$		1508			
Input Capacitance	C_{iss}			111		pF	Fig. 11
Output Capacitance	C_{oss}			19			
Reverse Transfer Capacitance	C_{rss}	$V_{DS} = 1000\text{ V}, V_{GS} = 0\text{ V}$ $f = 1\text{ MHz}, V_{AC} = 25\text{ mV}$		5.0			
C_{oss} Stored Energy	E_{oss}			10		μJ	Fig. 12
C_{oss} Stored Charge	Q_{oss}			23		nC	
Gate-Source Charge	Q_{gs}	$V_{DS} = 1000\text{ V}, V_{GS} = -5 / +20\text{ V}$		2		nC	Fig. 10
Gate-Drain Charge	Q_{gd}	$I_D = 2\text{ A}$		7			
Total Gate Charge	Q_g	Per IEC607478-4		11			
Internal Gate Resistance	$R_{G(int)}$	$f = 1\text{ MHz}, V_{AC} = 25\text{ mV}$		5.0		Ω	
Turn-On Switching Energy (Body Diode)	E_{on}	$T_j = 25^\circ\text{C}, V_{GS} = -5/+20\text{ V}, R_{G(ext)} = 20\ \Omega, L = 1000.0\ \mu\text{H}, I_D = 2\text{ A}, V_{DD} = 1200\text{ V}$		54		μJ	Fig. 22
Turn-Off Switching Energy (Body Diode)	E_{off}			16			
Turn-On Delay Time	$t_{d(on)}$			11		ns	Fig. 24
Rise Time	t_r	$V_{DD} = 1200\text{ V}, V_{GS} = -5/+20\text{ V}$		19			
Turn-Off Delay Time	$t_{d(off)}$	$R_{G(ext)} = 20\ \Omega, L = 1000.0\ \mu\text{H}, I_D = 2\text{ A}$		13			
Fall Time	t_f	Timing relative to V_{DS} , Inductive load		16			

Reverse Diode Characteristics

Parameter	Symbol	Conditions	Values			Unit	Note
			Min.	Typ.	Max.		
Diode Forward Voltage	V_{SD}	$V_{GS} = -5\text{ V}, I_{SD} = 1\text{ A}$		4.0		V	Fig. 17-18
		$V_{GS} = -5\text{ V}, I_{SD} = 1\text{ A}, T_j = 175^\circ\text{C}$		3.6			
Continuous Diode Forward Current	I_S	$V_{GS} = -5\text{ V}, T_C = 100^\circ\text{C}$	3			A	
Diode Pulse Current	$I_{S(pulse)}$	$V_{GS} = -5\text{ V}, \text{Note 1}$		12		A	
Reverse Recovery Time	t_{rr}			21		ns	
Reverse Recovery Charge	Q_{rr}	$V_{GS} = -5\text{ V}, I_{SD} = 2\text{ A}, V_R = 1200\text{ V}$ $dif/dt = 550\text{ A}/\mu\text{s}, T_j = 25^\circ\text{C}$		27		nC	
Peak Reverse Recovery Current	I_{rrm}			2		A	
Reverse Recovery Time	t_{rr}			36		ns	
Reverse Recovery Charge	Q_{rr}	$V_{GS} = -5\text{ V}, I_{SD} = 2\text{ A}, V_R = 1200\text{ V}$ $dif/dt = 550\text{ A}/\mu\text{s}, T_j = 175^\circ\text{C}$		101		nC	
Peak Reverse Recovery Current	I_{rrm}			5		A	

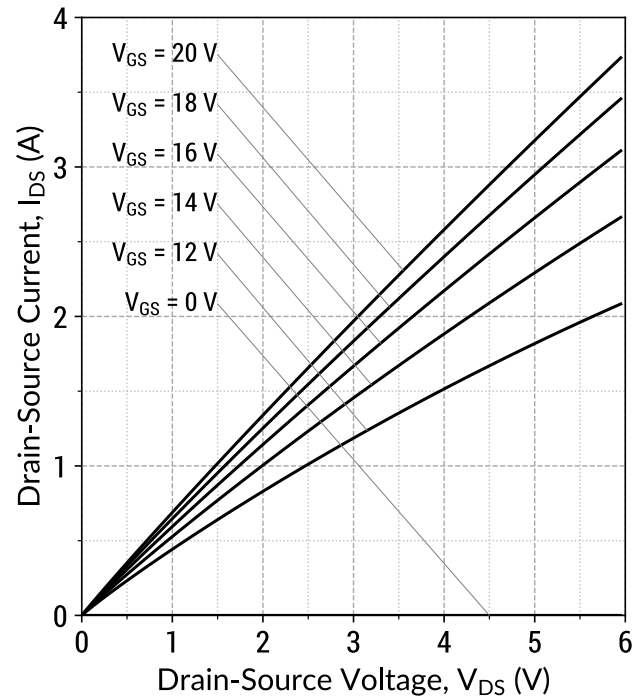
*The chip technology was characterized up to 200 V/ns. The measured dV/dt was limited by measurement test setup and package.

Figure 1: Output Characteristics ($T_j = 25^\circ\text{C}$)



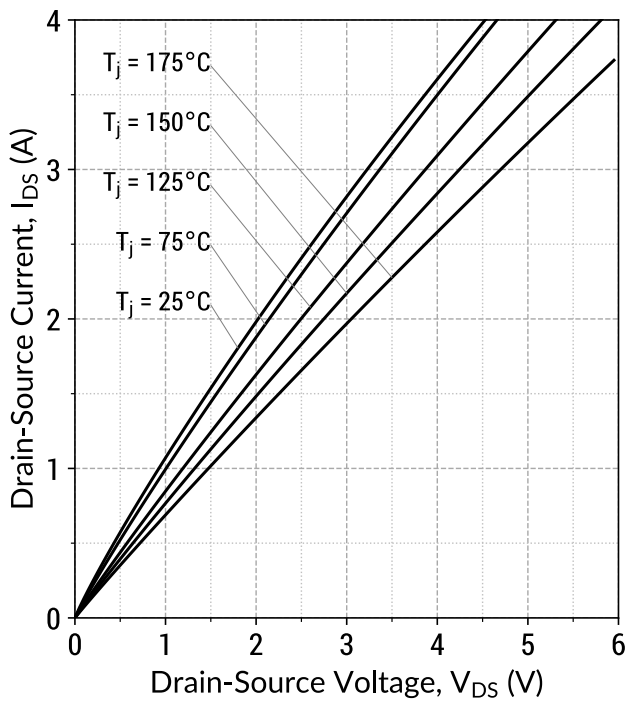
$I_D = f(V_{DS}, V_{GS}); t_P = 250 \mu\text{s}$

Figure 2: Output Characteristics ($T_j = 175^\circ\text{C}$)



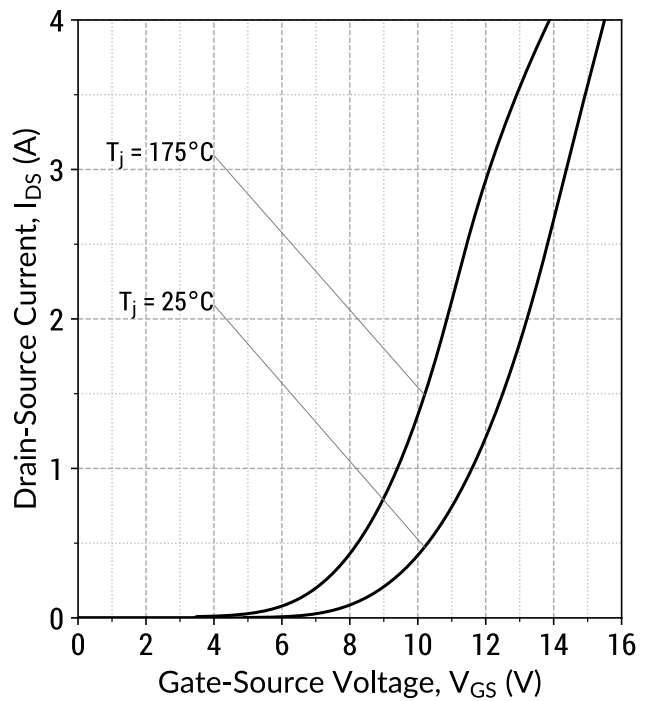
$I_D = f(V_{DS}, V_{GS}); t_P = 250 \mu\text{s}$

Figure 3: Output Characteristics ($V_{GS} = 20\text{ V}$)



$I_D = f(V_{DS}, T_j); t_P = 250 \mu\text{s}$

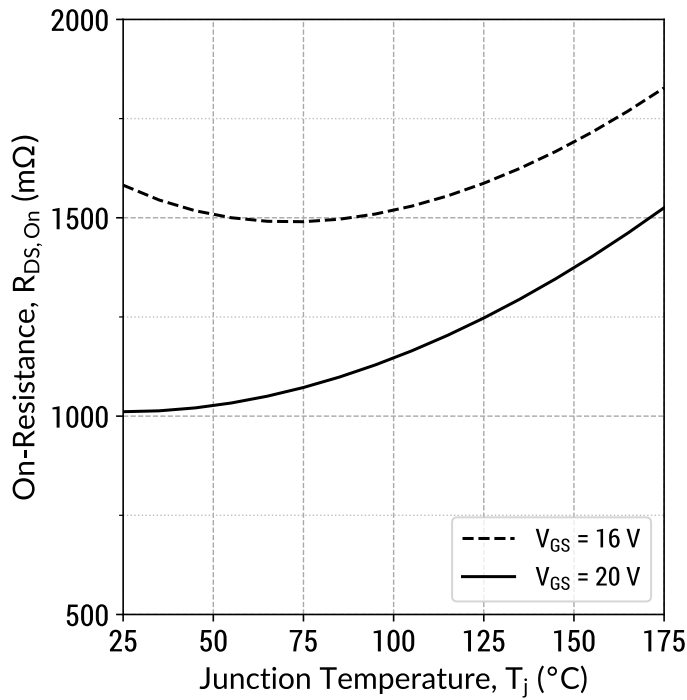
Figure 4: Transfer Characteristics ($V_{DS} = 10\text{ V}$)



$I_D = f(V_{GS}, T_j); t_P = 100 \mu\text{s}$

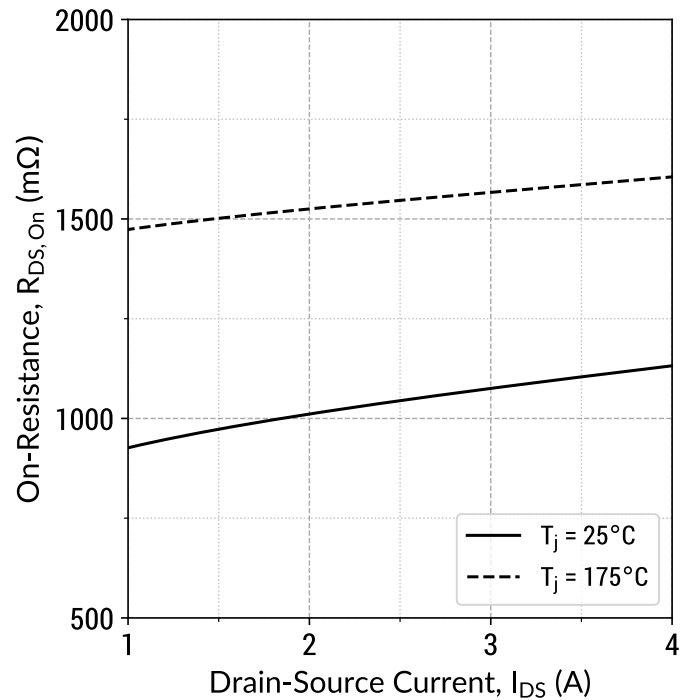


Figure 5: On-State Resistance v/s Temperature



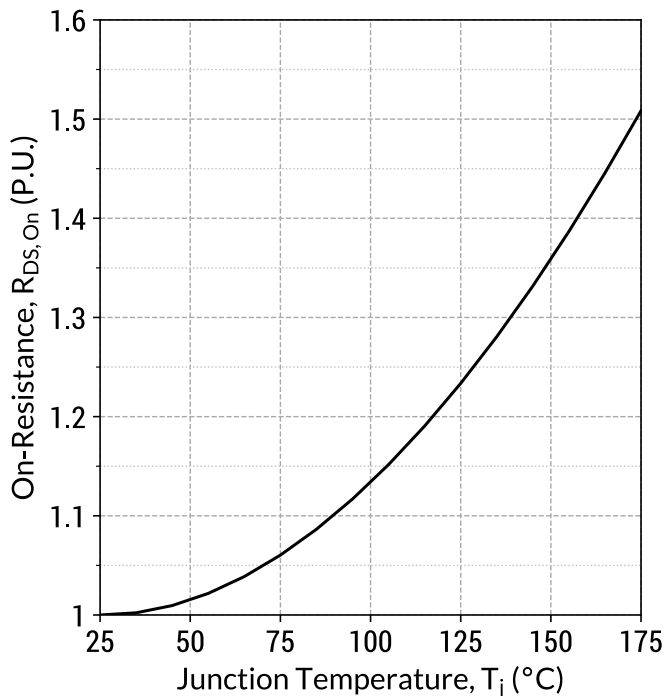
$$R_{DS(ON)} = f(T_j, V_{GS}); t_P = 250 \mu\text{s}; I_D = 2\text{ A}$$

Figure 6: On-State Resistance v/s Drain Current



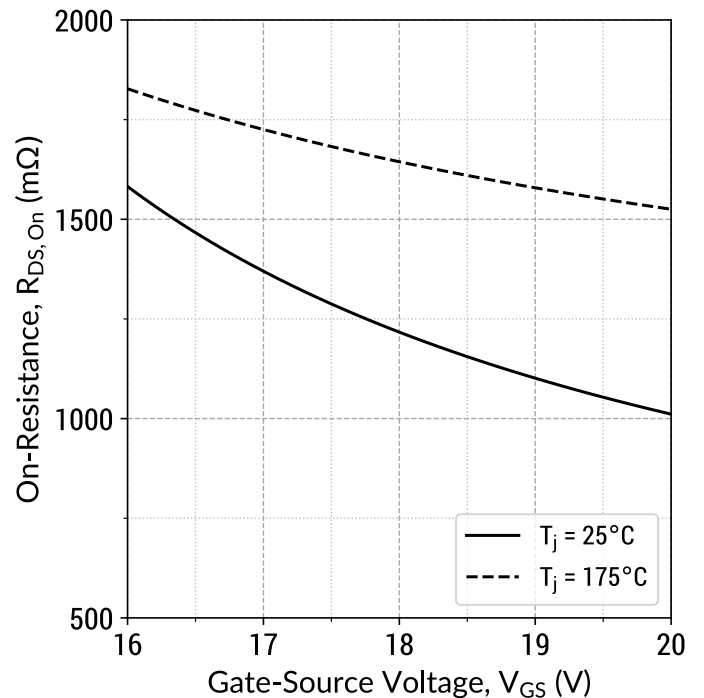
$$R_{DS(ON)} = f(T_j, I_D); t_P = 250 \mu\text{s}; V_{GS} = 20\text{ V}$$

Figure 7: Normalized On-State Resistance v/s Temperature



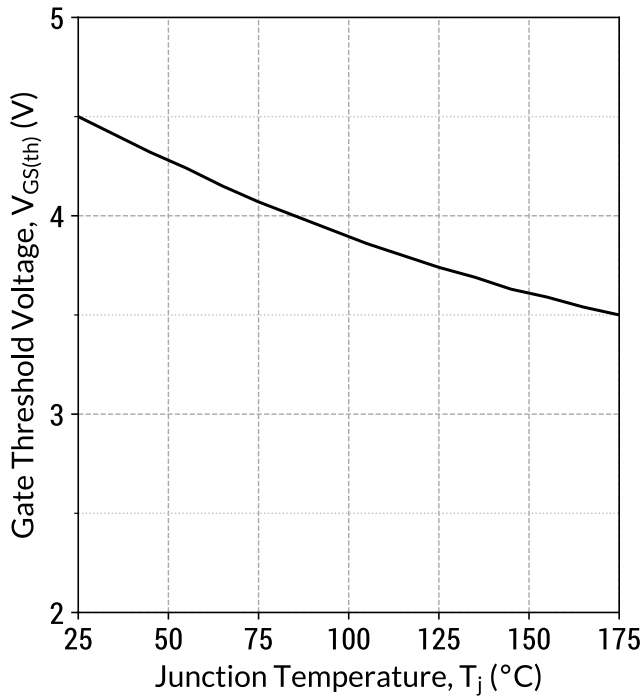
$$R_{DS(ON)} = f(T_j); t_P = 250 \mu\text{s}; I_D = 2\text{ A}; V_{GS} = 20\text{ V}$$

Figure 8: On-State Resistance v/s Gate Voltage



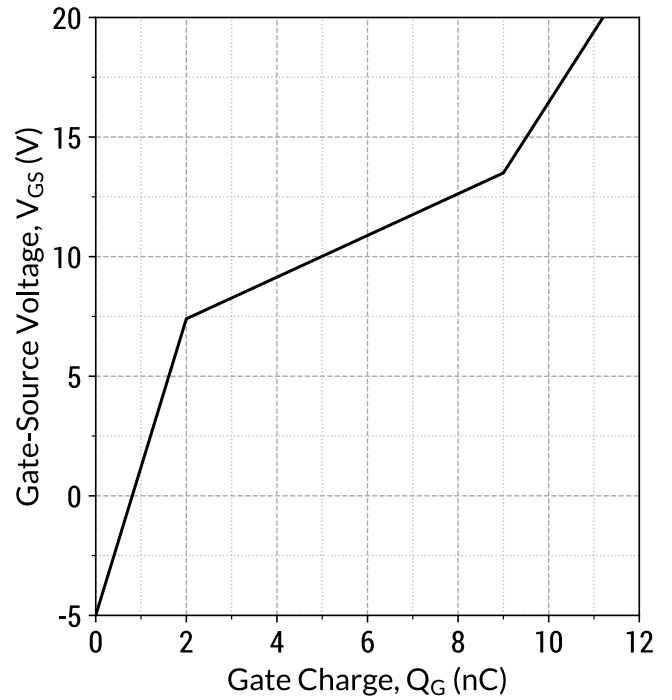
$$R_{DS(ON)} = f(T_j, V_{GS}); t_P = 250 \mu\text{s}; I_D = 2\text{ A}$$

Figure 9: Threshold Voltage Characteristics



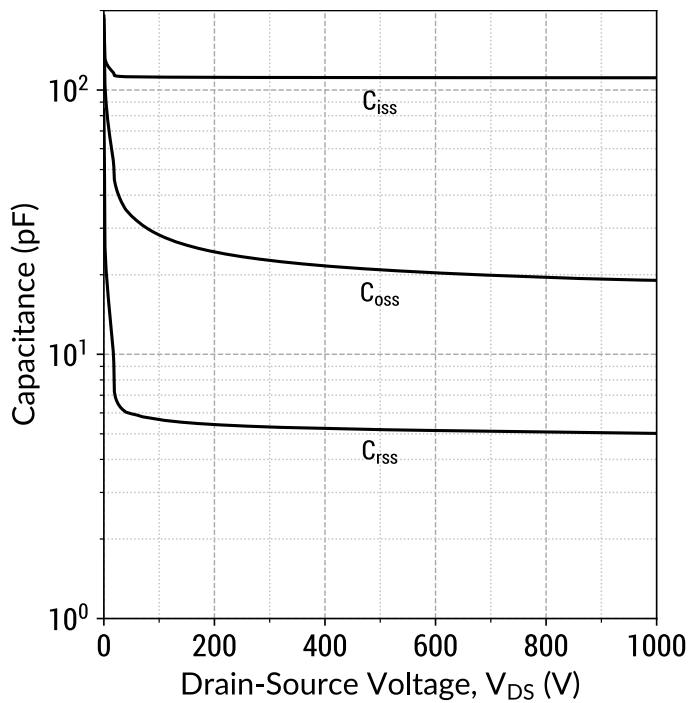
$V_{GS(th)} = f(T_j); V_{DS} = V_{GS}; I_D = 1.0 \text{ mA}$

Figure 10: Gate Charge Characteristics



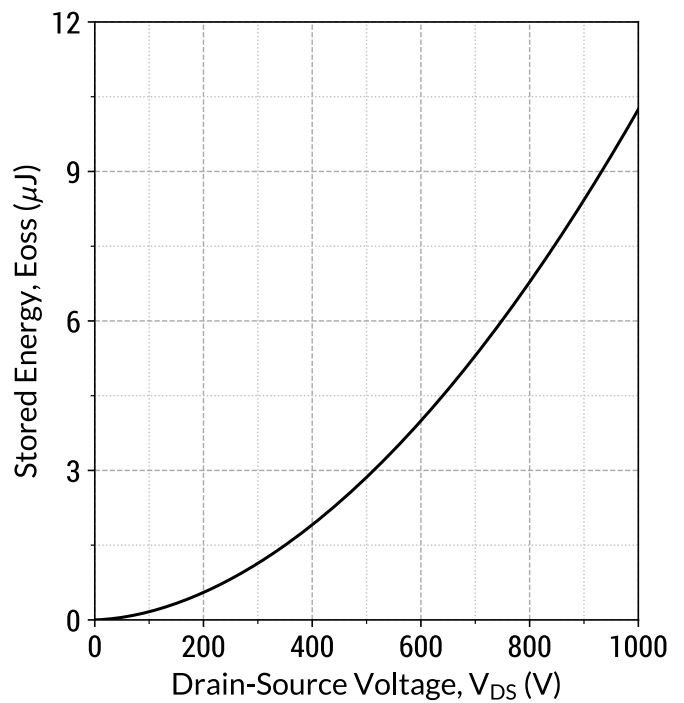
$I_D = 2 \text{ A}; V_{DS} = 1000 \text{ V}; T_c = 25^\circ\text{C}$

Figure 11: Capacitance v/s Drain-Source Voltage



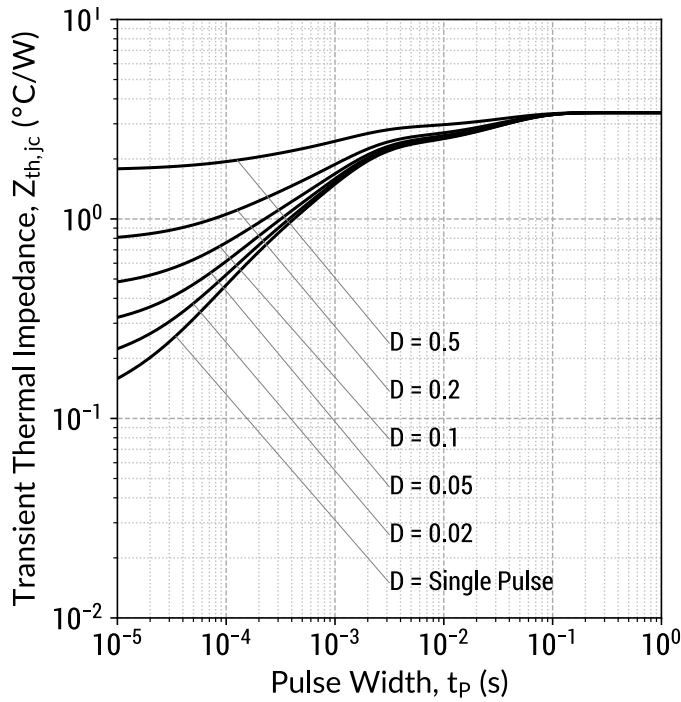
$f = 1 \text{ MHz}; V_{AC} = 25\text{mV}$

Figure 12: Output Capacitor Stored Energy



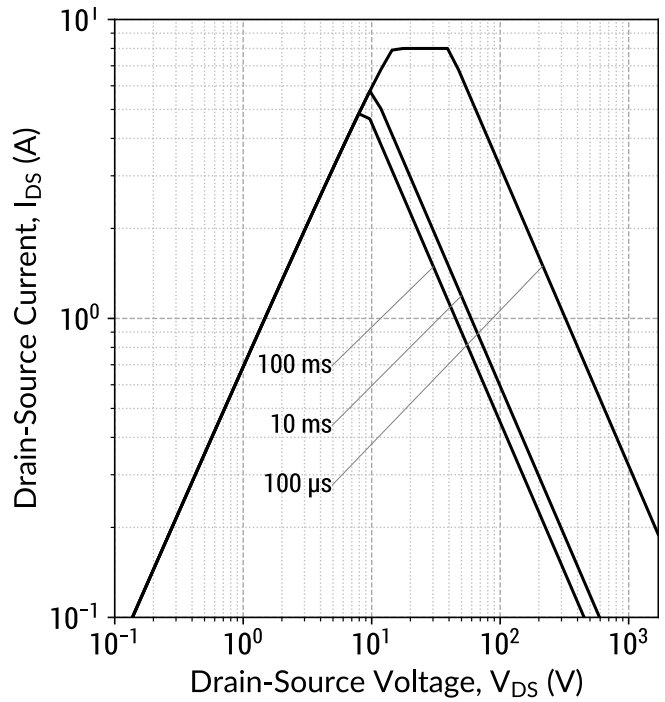
$E_{oss} = f(V_{DS})$

Figure 13: Transient Thermal Impedance



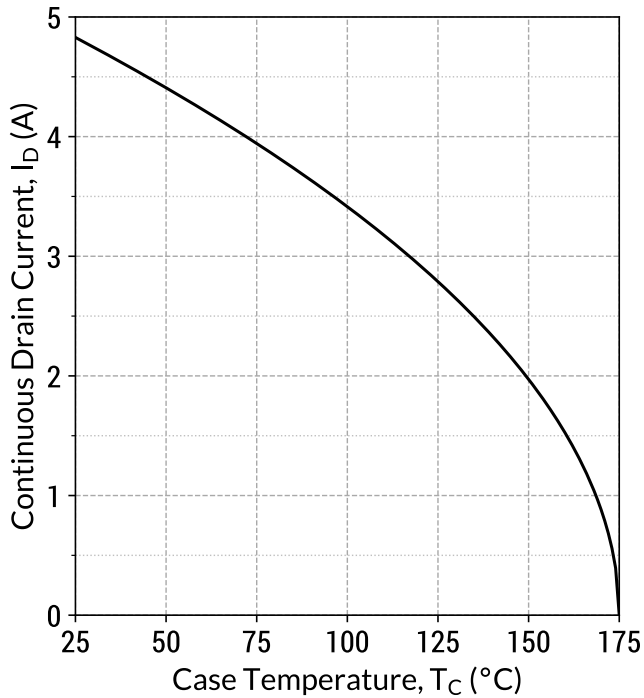
$$Z_{th,jc} = f(t_p, D); D = t_p/T$$

Figure 14: Safe Operating Area ($T_c = 25^\circ\text{C}$)



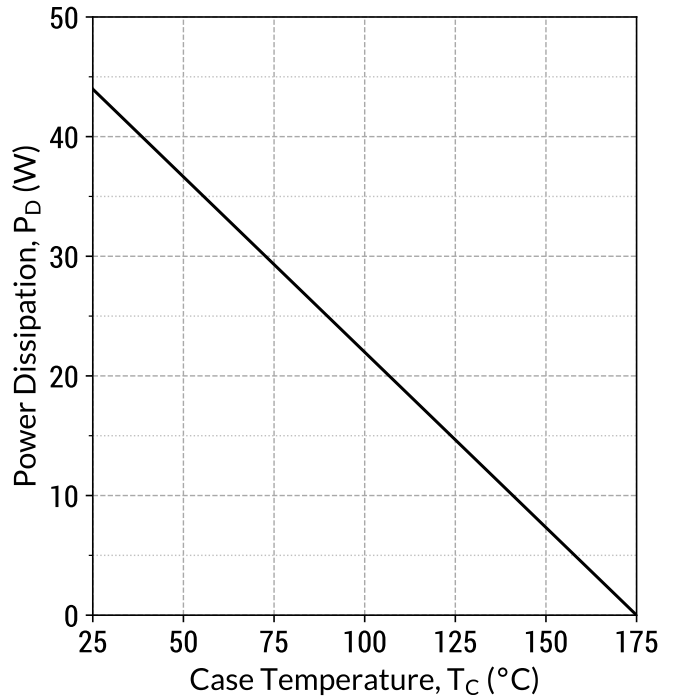
$$I_D = f(V_{DS}, t_p); T_j \leq 175^\circ\text{C}; D = 0$$

Figure 15: Current De-rating Curve



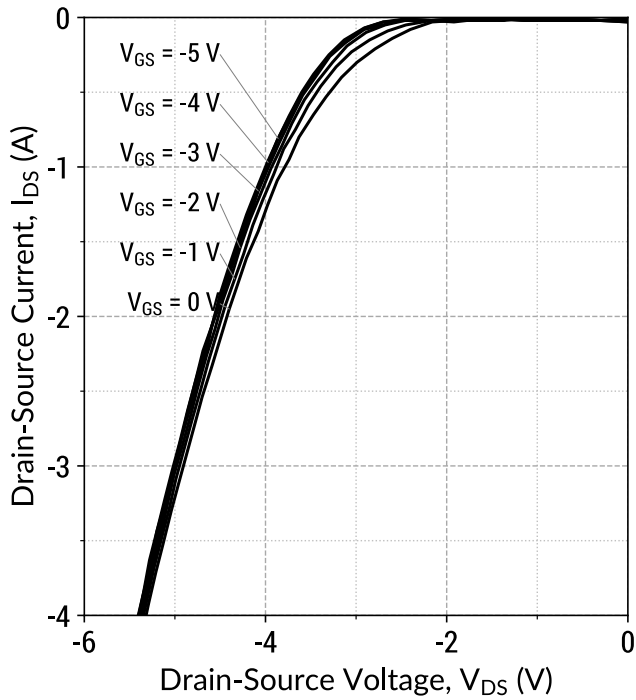
$$I_D = f(T_c); T_j \leq 175^\circ\text{C}$$

Figure 16: Power De-rating Curve



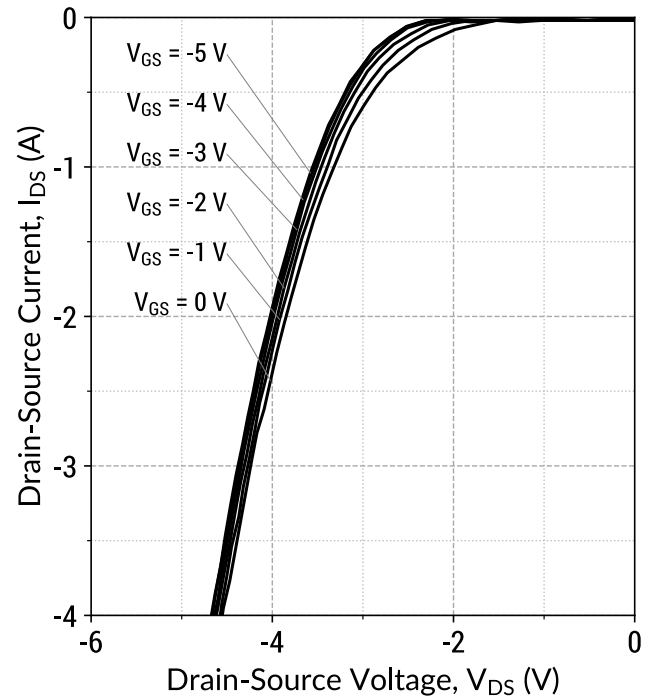
$$P_D = f(T_c); T_j \leq 175^\circ\text{C}$$

Figure 17: Body Diode Characteristics ($T_j = 25^\circ\text{C}$)



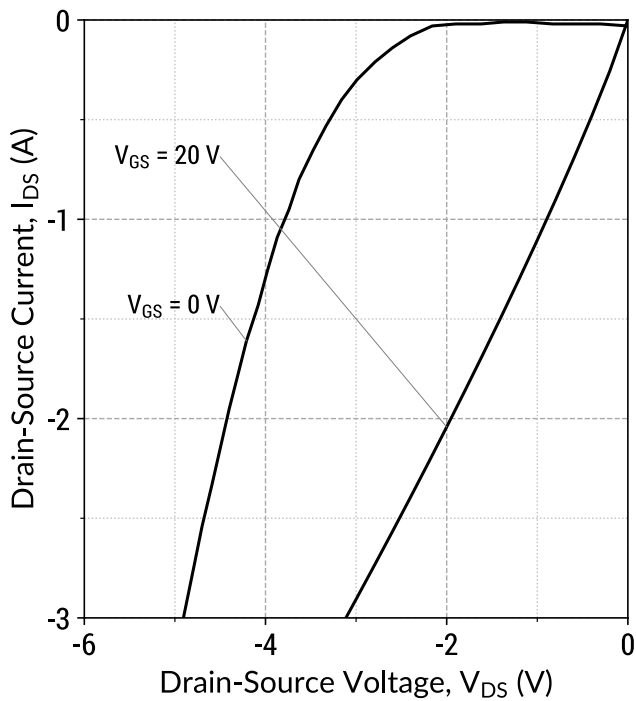
$$I_D = f(V_{DS}, V_{GS}); t_P = 250 \mu\text{s}$$

Figure 18: Body Diode Characteristics ($T_j = 175^\circ\text{C}$)



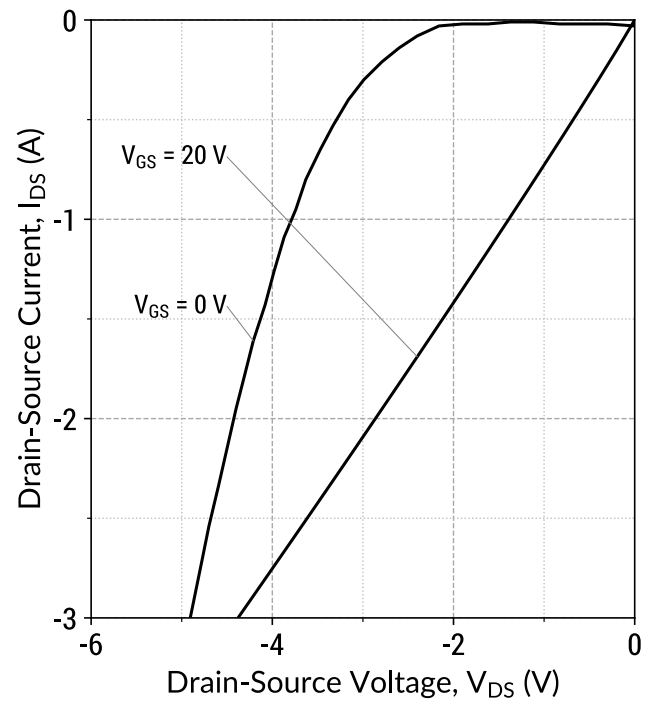
$$I_D = f(V_{DS}, V_{GS}); t_P = 250 \mu\text{s}$$

Figure 19: Third Quadrant Characteristics ($T_j = 25^\circ\text{C}$)



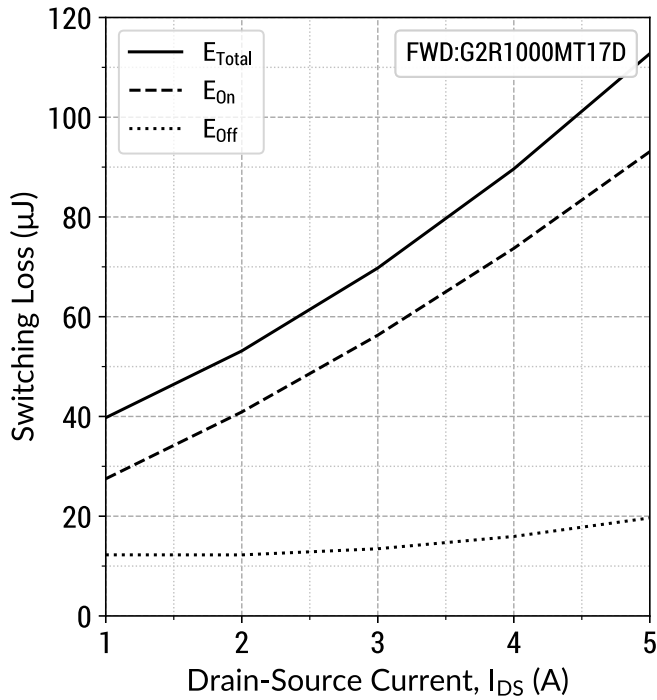
$$I_D = f(V_{DS}, V_{GS}); t_P = 250 \mu\text{s}$$

Figure 20: Third Quadrant Characteristics ($T_j = 175^\circ\text{C}$)



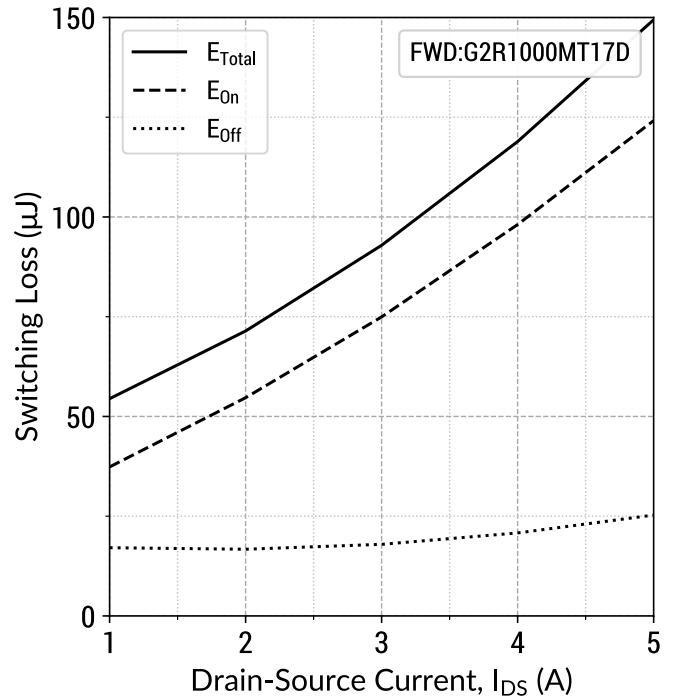
$$I_D = f(V_{DS}, V_{GS}); t_P = 250 \mu\text{s}$$

Figure 21: Inductive Switching Energy v/s Drain Current ($V_{DD} = 1000V$)



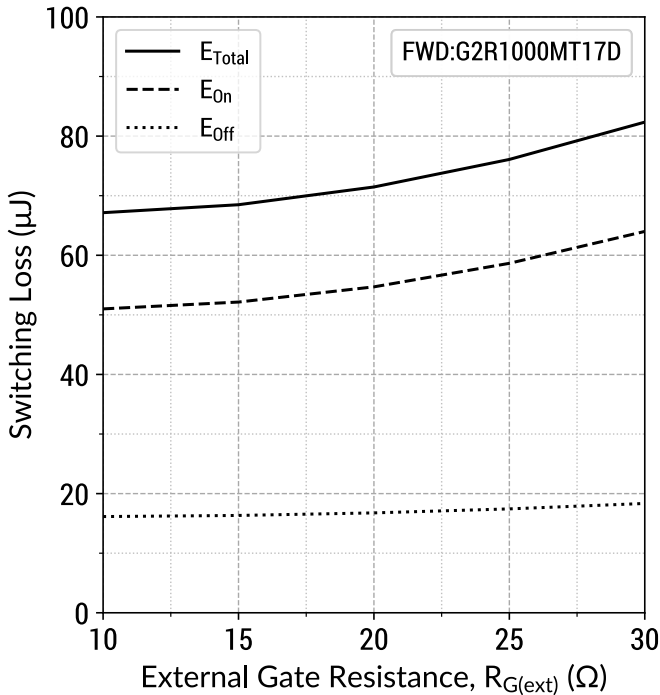
$T_j = 25^\circ C$; $V_{GS} = -5/+20V$; $R_{G(ext)} = 20 \Omega$; $L = 1000.0\mu H$

Figure 22: Inductive Switching Energy v/s Drain Current ($V_{DD} = 1200V$)



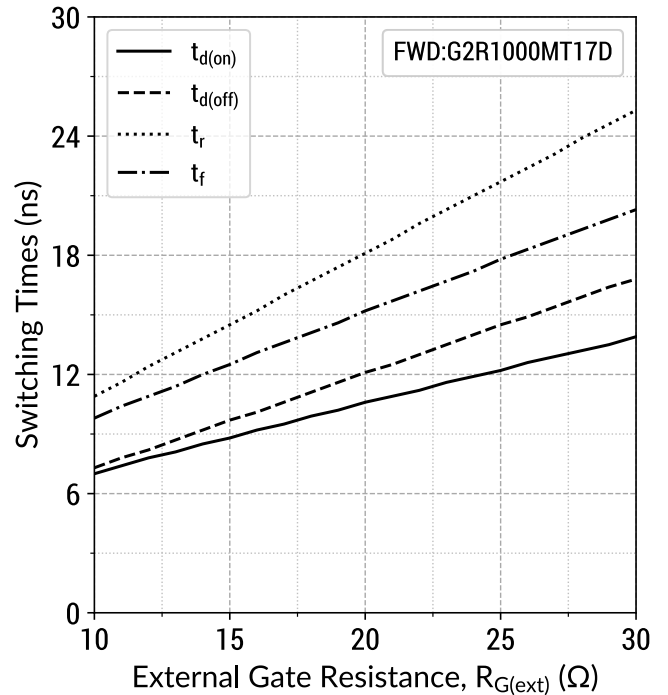
$T_j = 25^\circ C$; $V_{GS} = -5/+20V$; $R_{G(ext)} = 20 \Omega$; $L = 1000.0\mu H$

Figure 23: Inductive Switching Energy v/s $R_{G(ext)}$ ($V_{DD} = 1200V$)



$T_j = 25^\circ C$; $V_{GS} = -5/+20V$; $I_{DS} = 2 A$; $L = 1000.0\mu H$

Figure 24: Switching Time v/s $R_{G(ext)}$ ($V_{DD} = 1200V$)

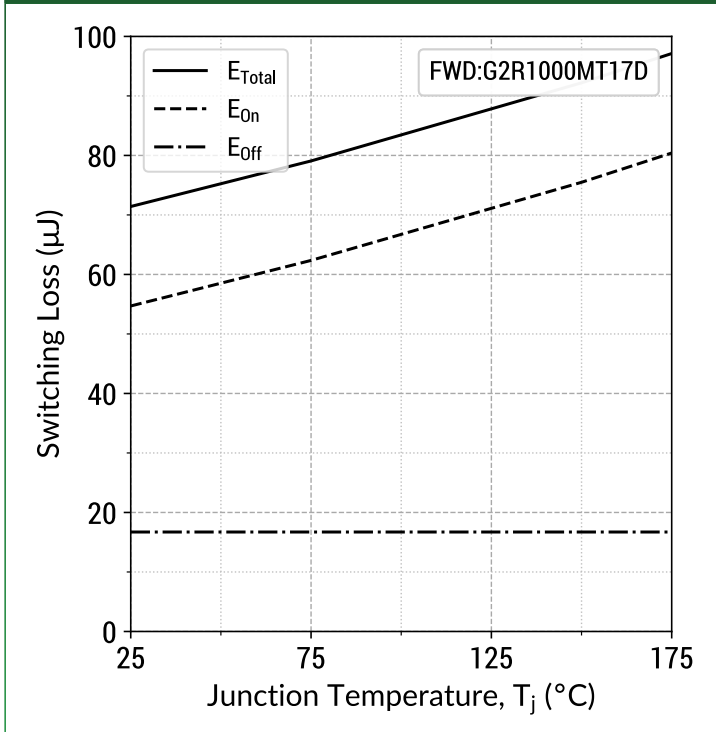


$T_j = 25^\circ C$; $V_{GS} = -5/+20V$; $I_{DS} = 2 A$; $L = 1000.0\mu H$

G2R1000MT17D

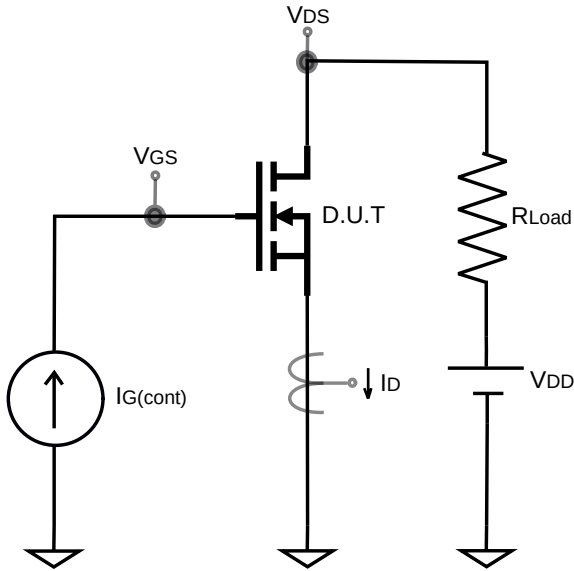
1700 V 1000 mΩ SiC MOSFET

Figure 25: Inductive Switching Energy v/s Temperature
($V_{DD} = 1200V$)

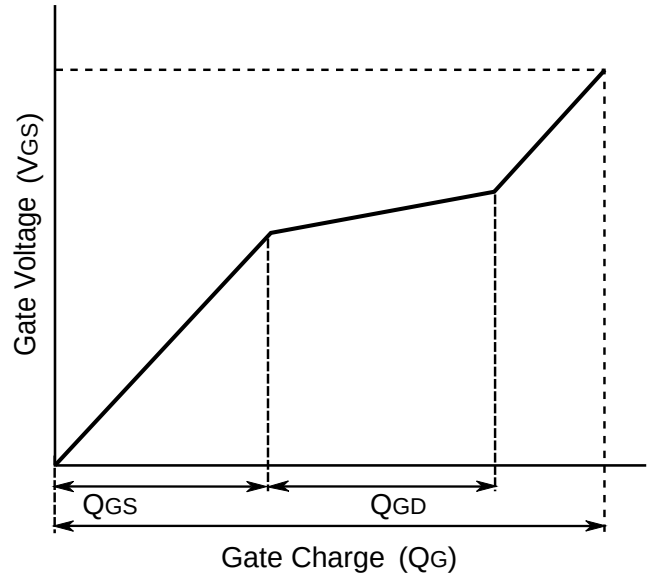


$T_j = 25^\circ C$; $V_{GS} = -5/+20V$; $R_{G(ext)} = 20 \Omega$; $I_{DS} = 2 A$; $L = 1000.0\mu H$

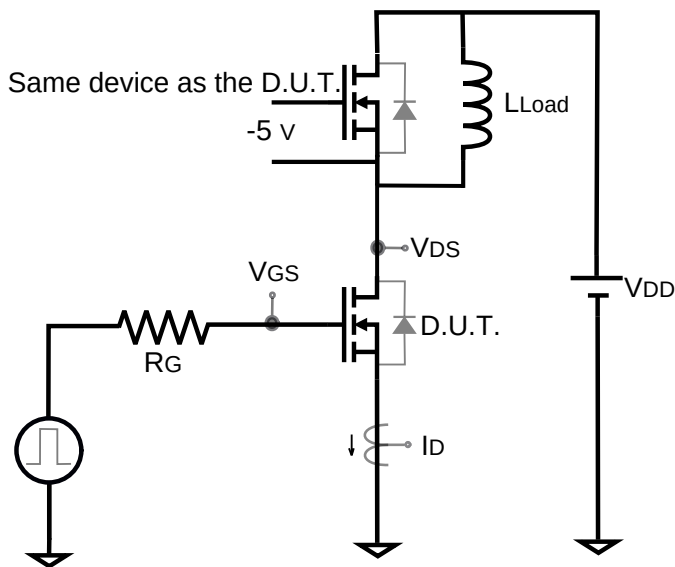
Gate Charge Circuit



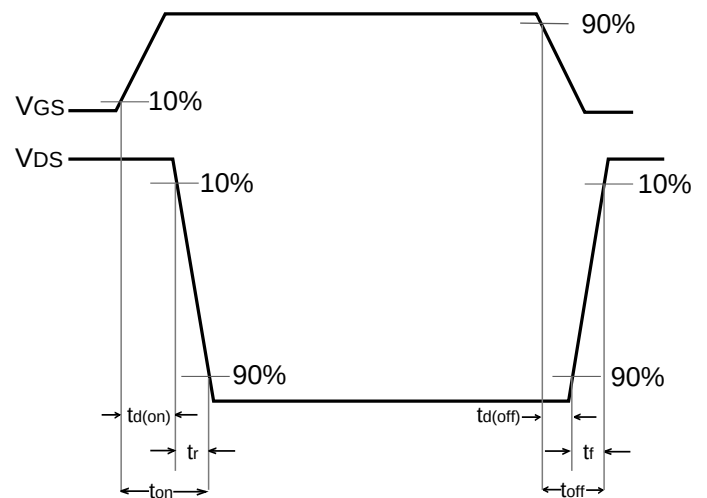
Gate Charge Waveform



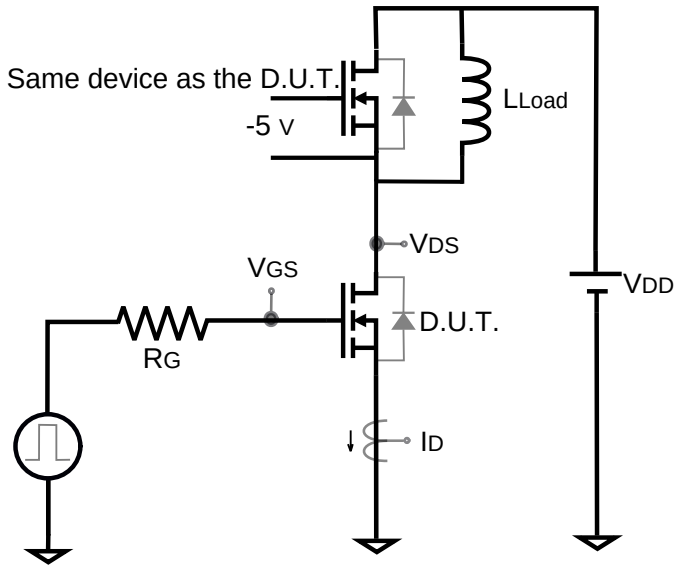
Switching Time Circuit



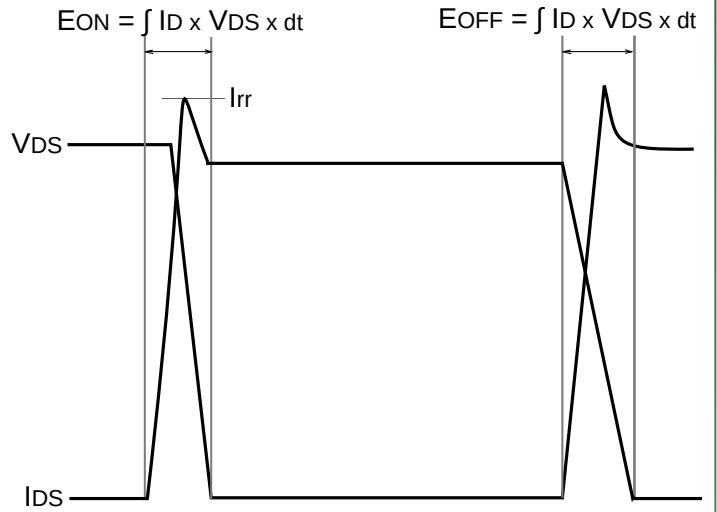
Switching Time Waveform



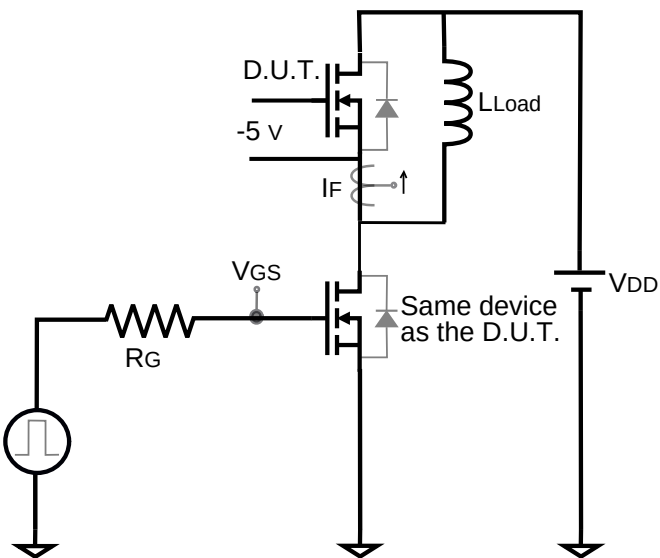
Switching Energy Circuit



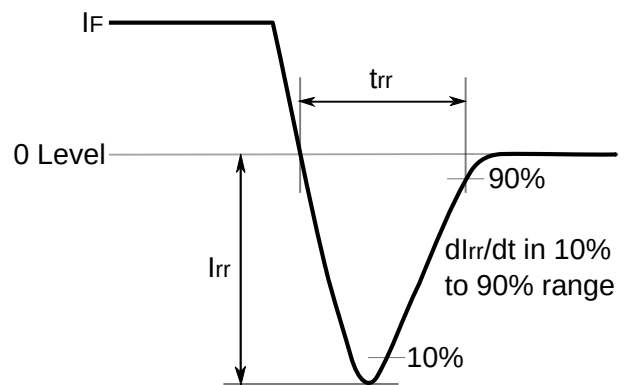
Switching Energy Waveform



Reverse Recovery Circuit

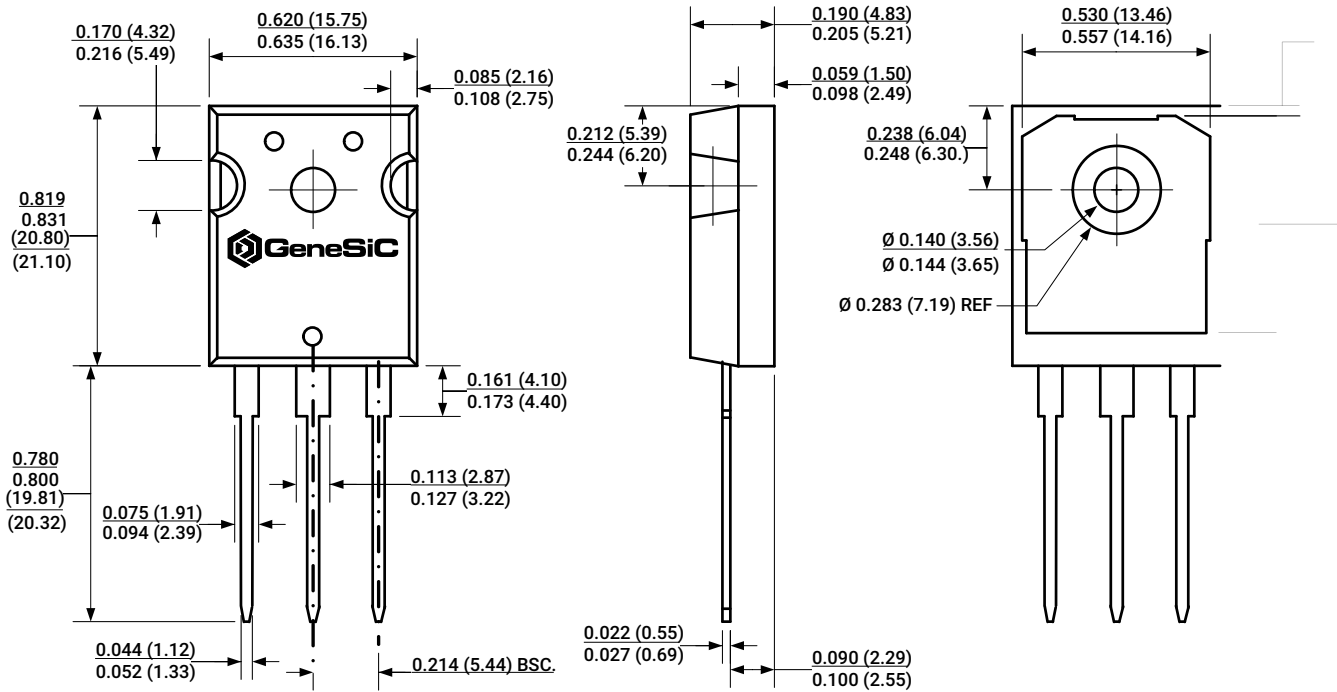


Reverse Recovery Waveform

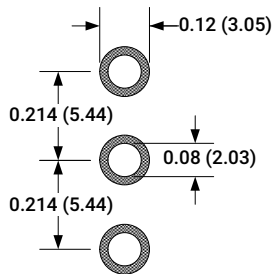


Package Dimensions

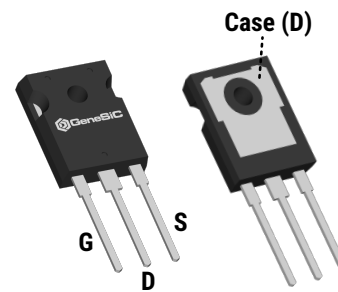
TO-247-3 Package Outline



Recommended Solder Pad Layout



Package View



NOTE

1. CONTROLLED DIMENSION IS INCH. DIMENSION IN BRACKET IS MILLIMETER.
2. DIMENSIONS DO NOT INCLUDE END FLASH, MOLD FLASH, MATERIAL PROTRUSIONS.

Compliance

RoHS Compliance

The levels of RoHS restricted materials in this product are below the maximum concentration values (also referred to as the threshold limits) permitted for such substances, or are used in an exempted application, in accordance with EU Directive 2011/65/EC (RoHS 2), as adopted by EU member states on January 2, 2013 and amended on March 31, 2015 by EU Directive 2015/863. RoHS Declarations for this product can be obtained from your GeneSiC representative.

REACH Compliance

REACH substances of high concern (SVHCs) information is available for this product. Since the European Chemical Agency (ECHA) has published notice of their intent to frequently revise the SVHC listing for the foreseeable future, please contact a GeneSiC representative to insure you get the most up-to-date REACH SVHC Declaration. REACH banned substance information (REACH Article 67) is also available upon request.

Disclaimer

GeneSiC Semiconductor, Inc. reserves right to make changes to the product specifications and data in this document without notice. GeneSiC disclaims all and any warranty and liability arising out of use or application of any product. No license, express or implied to any intellectual property rights is granted by this document.

Unless otherwise expressly indicated, GeneSiC products are not designed, tested or authorized for use in life-saving, medical, aircraft navigation, communication, air traffic control and weapons systems, nor in applications where their failure may result in death, personal injury and/or property damage.

Related Links

- SPICE Models: https://www.genesicsemi.com/sic-mosfet/G2R1000MT17D/G2R1000MT17D_SPICE.zip
- PLECS Models: https://www.genesicsemi.com/sic-mosfet/G2R1000MT17D/G2R1000MT17D_PLECS.zip
- CAD Models: https://www.genesicsemi.com/sic-mosfet/G2R1000MT17D/G2R1000MT17D_3D.zip
- Gate Driver Reference: <https://www.genesicsemi.com/technical-support>
- Evaluation Boards: <https://www.genesicsemi.com/technical-support>
- Reliability: <https://www.genesicsemi.com/reliability>
- Compliance: <https://www.genesicsemi.com/compliance>
- Quality Manual: <https://www.genesicsemi.com/quality>

Revision History

- Rev 21/Feb: Updated with most recent test data
- Supersedes: Rev 20/Jun, Rev 20/Aug



www.genesicsemi.com/sic-mosfet/