

Title		State-Variable 1	
Size	Document Number	Rev	
A4	1		
Date:	Wednesday, October 14, 2009	Sheet	1 of 2

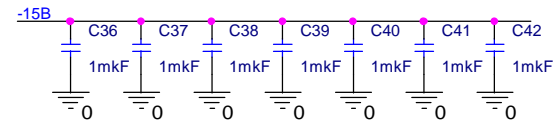
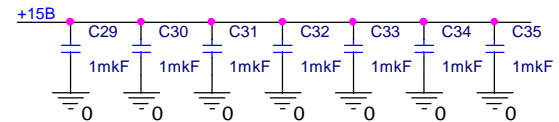
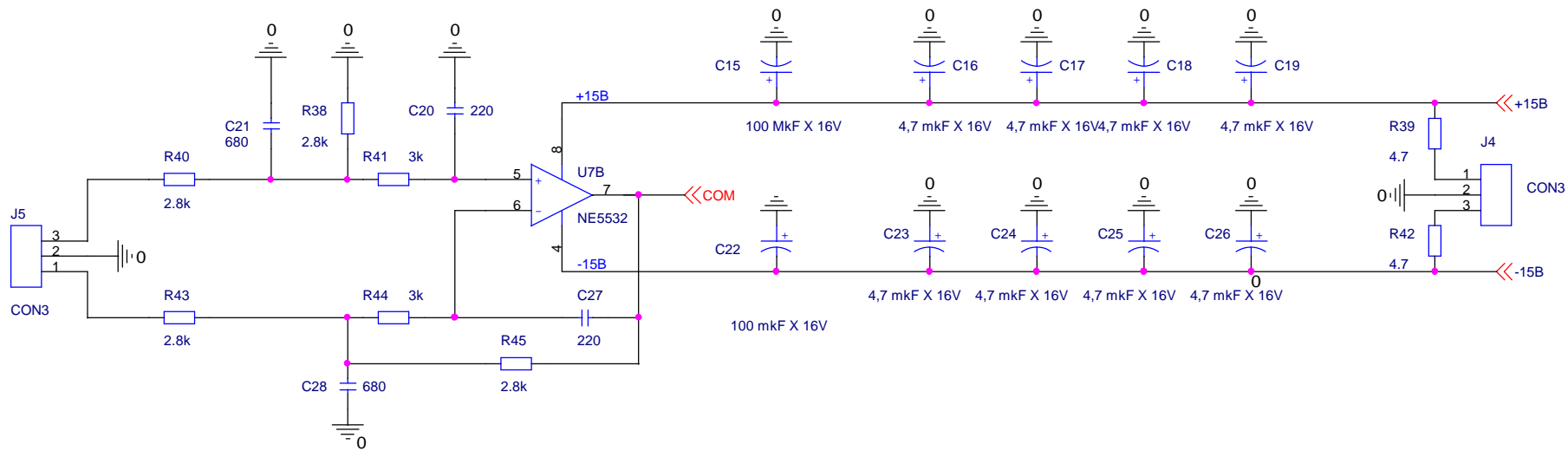

Title		
State-Variable 2		
Size	Document Number	Rev
A4	2	<RevCode>
Date:	Wednesday, October 14, 2009	Sheet 2 of 2

A4X

Ampl

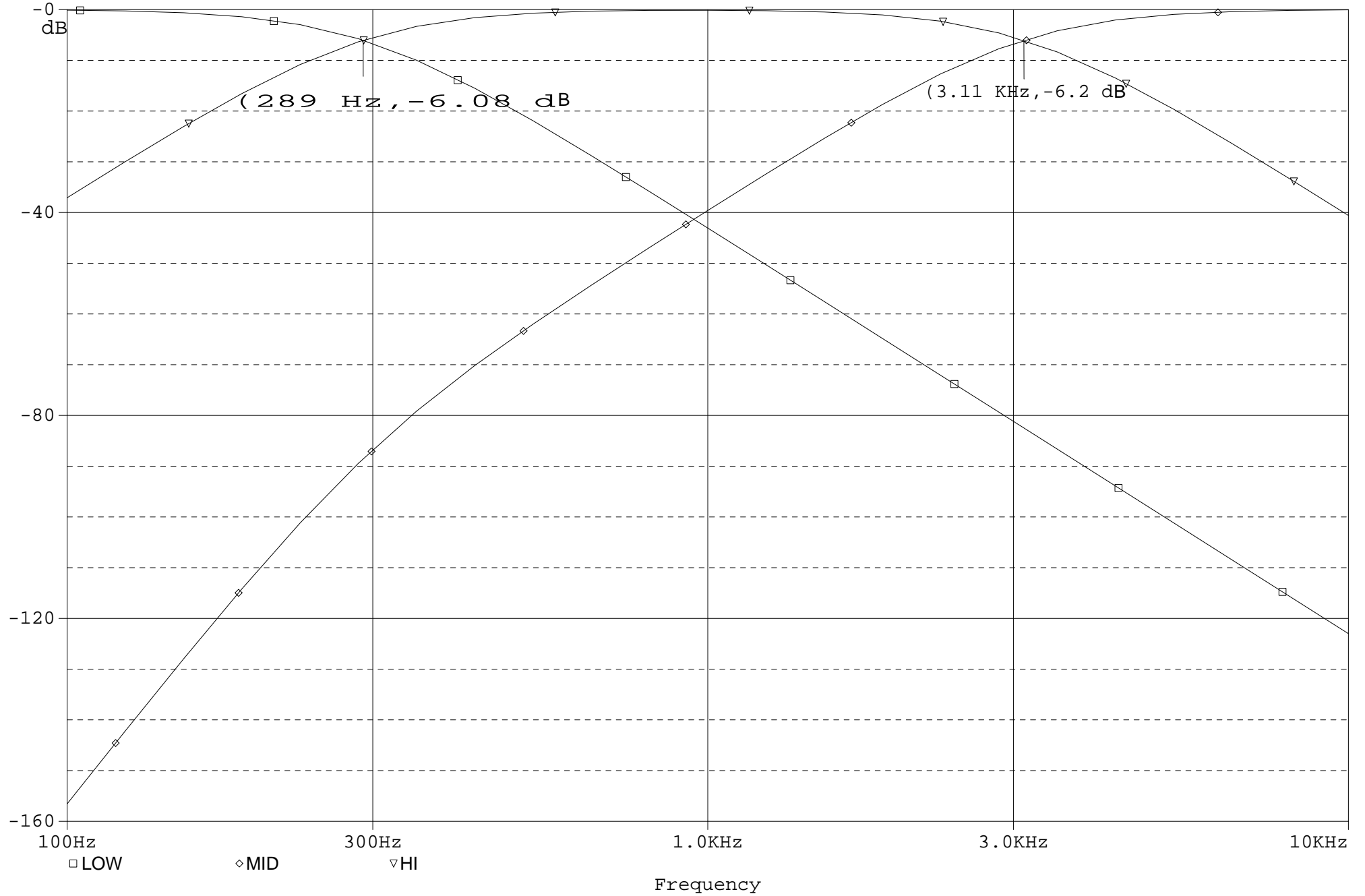

ΦЧХ

Phase

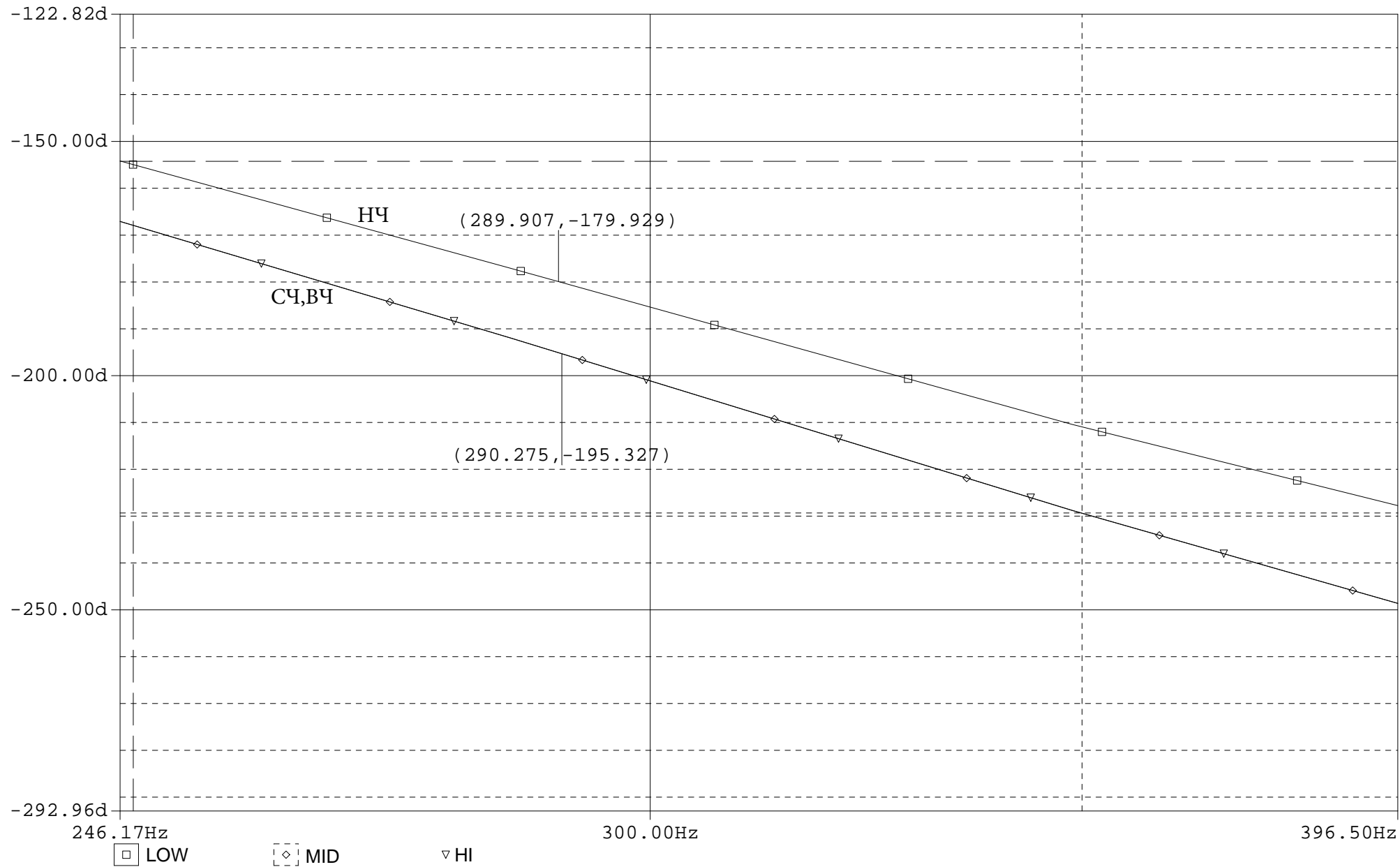

# TOP

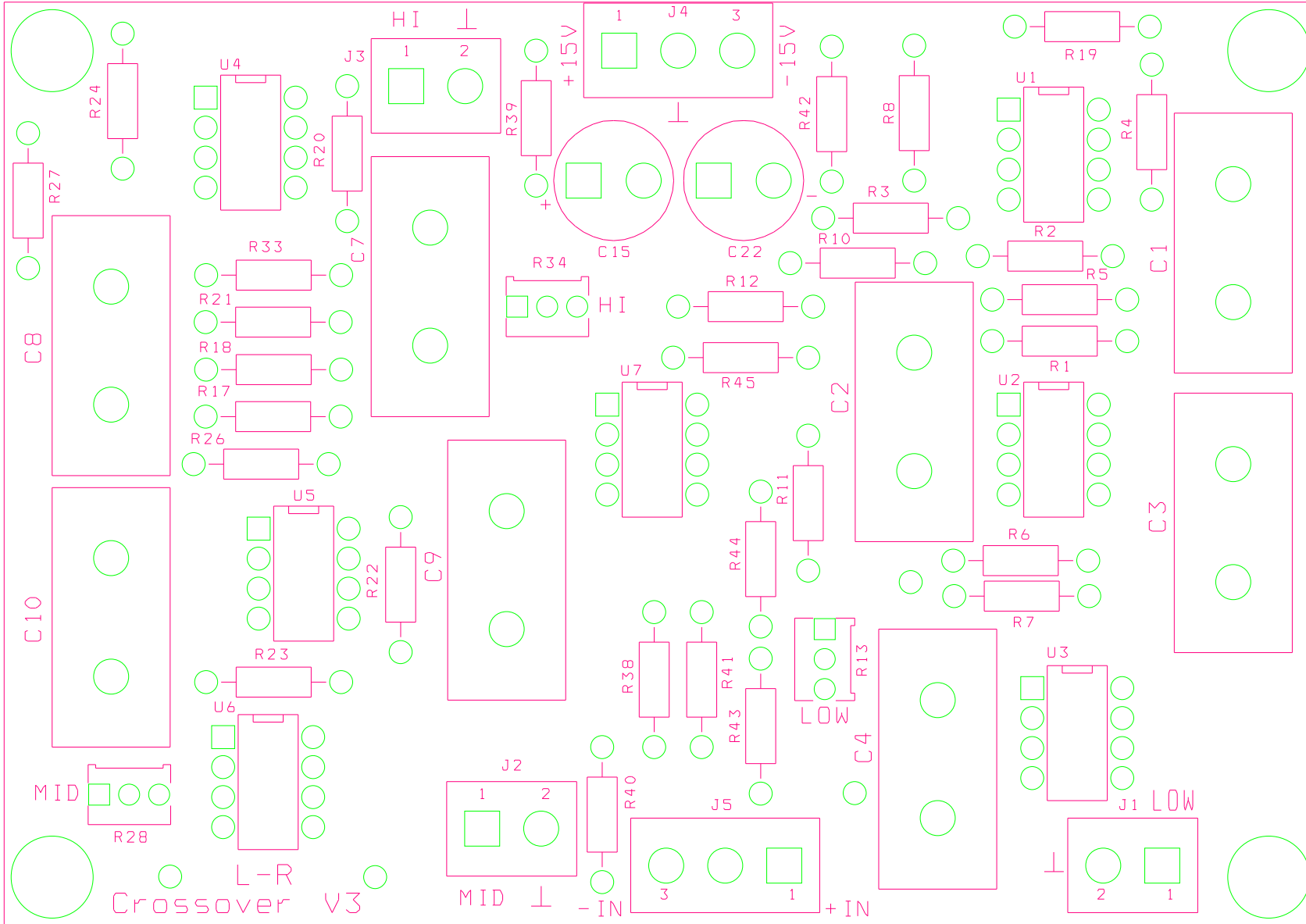

# BOT

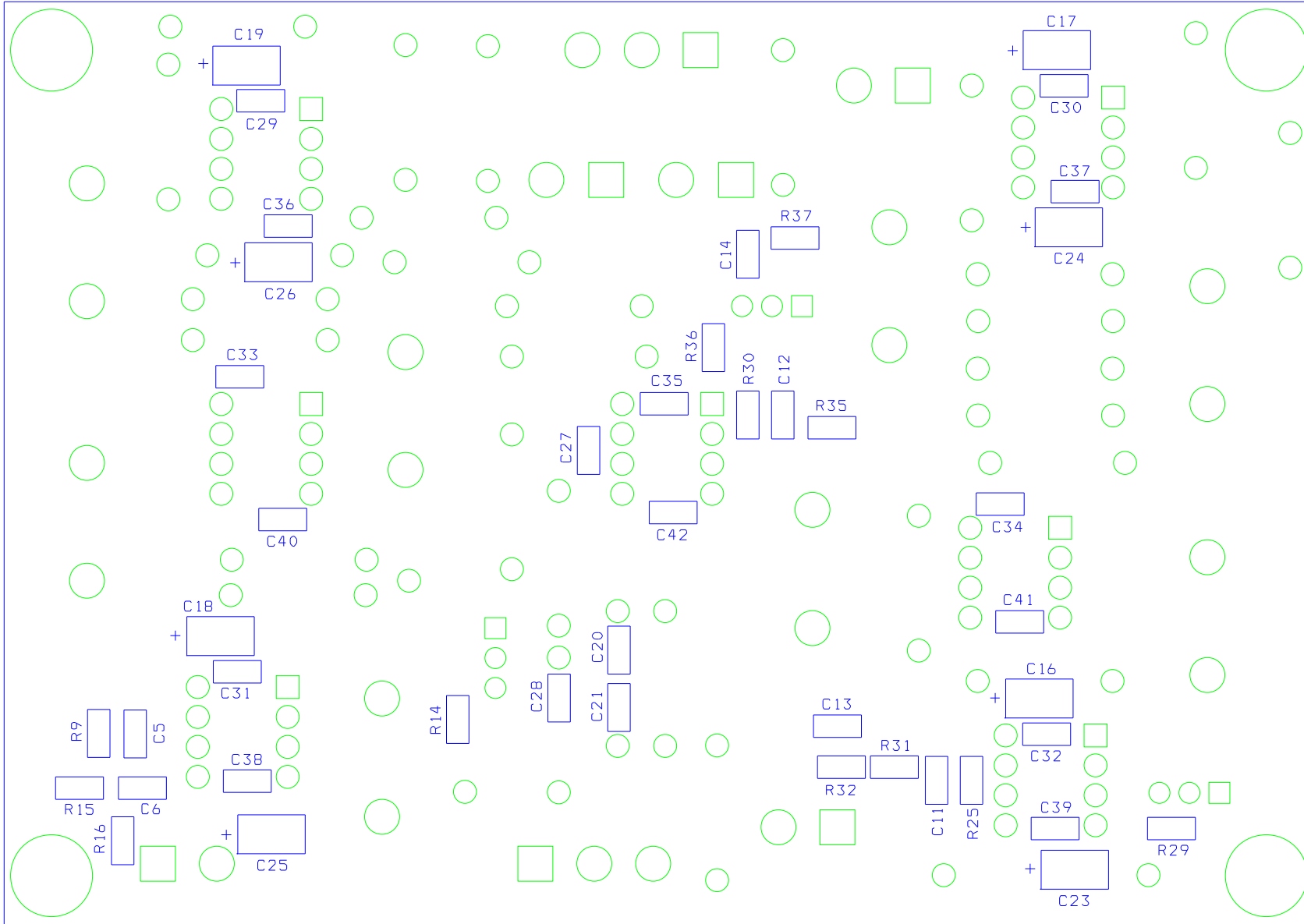

TOP

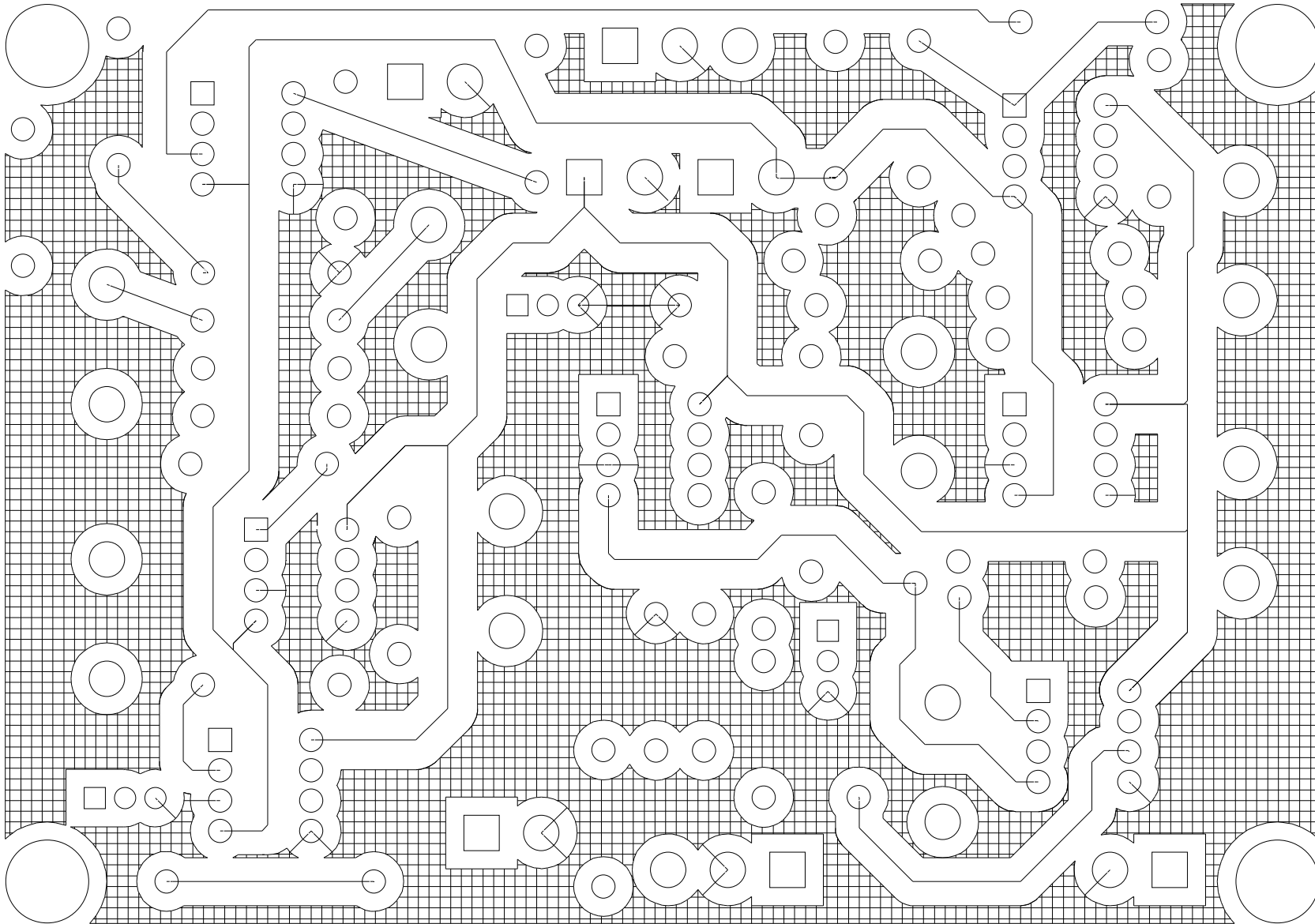

BOT

